



## VOL : VOLUMETRIC LED TROFFER

### FEATURES

- Architectural recessed luminaire
- Direct/indirect illumination for visual comfort with minimal glare
- Clean line styling complements today's modern office decor
- One for one alternative LED solution to fluorescent luminaires/ fixtures/troffers
- PowerSet feature allows for multiple "set and forget" lumen stops in each fixture
- FieldCCeT feature allows for multiple "set and forget" CCT options in each fixture
- Up to 50% energy savings over fluorescent troffers
- 0-10V dimmable standard
- Up to 140 lumens per watt\*
- Available in 2'x2' and 2'x4'

### LISTINGS

- UL Listed for dry/damp locations
- IC Rated for insulation contact
- DesignLights Consortium® Premium Qualified - meets the requirements for the highest DLC qualification for efficacy and lumen maintenance

### LED CHARACTERISTICS

- Rated lifetime L90: >54,000hrs
- PowerSet: 3500K, 4000K, or 5000K CCT options
- FieldCCeT: 3500K/4000K/5000K selectable
- CRI: 80+

### ELECTRICAL

- Input voltage: 120-347V
- Dimming Control: 0-10V (Dim-to-Off)
- Power Factor: >.90
- THD: <10%

### CONSTRUCTION

- Reflector precision die-formed, powder-coated, steel construction
- Custom extruded acrylic lens provides even illumination and visual comfort
- Integral earthquake clips
- -4°F to 104°F (-20°C to 40°C) operating temperature

### WARRANTY

- 5 year limited warranty; see eiko.com for warranty details
- Additional warranty options available; consult EiKO for details

\*At lowest available power setting; typical performance at highest setting is 130 lpw

|                |         |
|----------------|---------|
| project name   | type    |
| catalog number |         |
| comments       | voltage |
| approved by    | date    |



### APPLICATIONS

- Conference rooms
- Retail
- Offices
- Hospitality
- Healthcare
- Schools
- Reception areas
- Corridors
- Foyer



## ORDERING INFORMATION

EXAMPLE: VOL22/PS40/835/HD

| Model                           | Size                                   | Package  | CRI/CCT   | Voltage             | Dimming                  | Options                           |
|---------------------------------|--|--|---|---------------------|--------------------------|-----------------------------------|
| <b>VOL</b> : Volumetric Troffer | <b>22</b> - 2'x2'<br><b>24</b> - 2'x4' | <b>PS40</b> - 40/32/26W; 5000/4000/3250lm<br><b>PS50</b> - 50/40/32W; 6250/5000/4000lm | <b>835</b> - 80CRI; 3500K<br><b>840</b> - 80CRI; 4000K<br><b>850</b> - 80CRI; 5000K<br><b>FCCT</b> - 80CRI; 35/40/5000K | <b>H</b> - 120-347V | <b>D</b> - 0-10V Dimming | See page 2 for additional options |

## PERFORMANCE SUMMARY

| Order Code | Item #             | Watts     | Nominal Lumens | LPW (Typical) | CCT         | CRI | Volts    | Fluor. Equiv.    | DLC Premium |
|------------|--------------------|-----------|----------------|---------------|-------------|-----|----------|------------------|-------------|
| 10992      | VOL22/PS40/835/HD  | 40/32/26W | 5000/4000/3250 | 130           | 3500K       | 80+ | 120-347V | 3x 17WT8, 2U31T8 | ✓           |
| 10993      | VOL22/PS40/840/HD  | 40/32/26W | 5000/4000/3250 | 130           | 4000K       | 80+ | 120-347V | 3x 17WT8, 2U31T8 | ✓           |
| 10994      | VOL22/PS40/850/HD  | 40/32/26W | 5000/4000/3250 | 130           | 5000K       | 80+ | 120-347V | 3x 17WT8, 2U31T8 | ✓           |
| 10996      | VOL24/PS50/835/HD  | 50/40/32W | 6250/5000/4000 | 130           | 3500K       | 80+ | 120-347V | 2x 32T8, 3x 32T8 | ✓           |
| 10997      | VOL24/PS50/840/HD  | 50/40/32W | 6250/5000/4000 | 130           | 4000K       | 80+ | 120-347V | 2x 32T8, 3x 32T8 | ✓           |
| 10998      | VOL24/PS50/850/HD  | 50/40/32W | 6250/5000/4000 | 130           | 5000K       | 80+ | 120-347V | 2x 32T8, 3x 32T8 | ✓           |
| 10995      | VOL22/PS40/FCCT/HD | 40/32/26W | 5000/4000/3250 | 130           | 35/40/5000K | 80+ | 120-347V | 3x 17WT8, 2U31T8 | ✓           |
| 10999      | VOL24/PS50/FCCT/HD | 50/40/32W | 6250/5000/4000 | 130           | 35/40/5000K | 80+ | 120-347V | 2x 32T8, 3x 32T8 | ✓           |

## ADDITIONAL FACTORY INSTALLED OPTIONS

EXAMPLE: VOL22/PS40/835/HD-EM5W

**EM5W** - 5W Emergency Battery

**EM7.8W** - 7.8W Emergency Battery

**EM15W** - 15W Emergency Battery

**EM30W** - 30W Emergency Battery

## AVAILABLE ACCESSORIES

| Order Code | Item #      | Description                   |
|------------|-------------|-------------------------------|
| 09898      | VOL22-SMK-W | 2x2 Surface Mount Kit, White  |
| 09899      | VOL24-SMK-W | 2x4 Surface Mount Kit, White  |
| 10366      | SLM22-RMK-A | 2x2 Recessed Mount Kit, White |
| 10368      | SLM24-RMK-A | 2x4 Recessed Mount Kit, White |

## DIMENSIONS

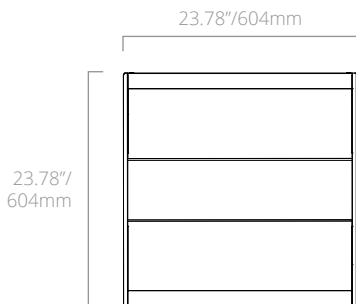

**VOL22**

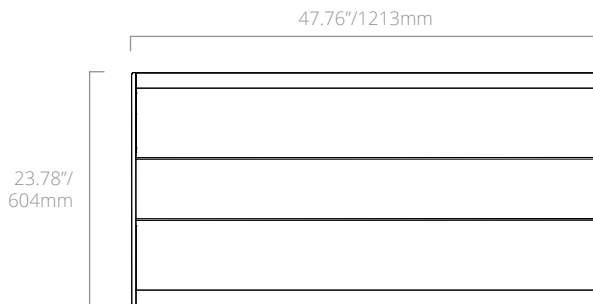

**VOL24**

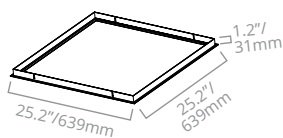

**SLM22-RMK-A**

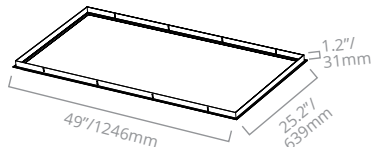

**SLM24-RMK-A**

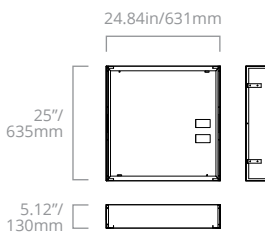

**VOL22-SMK-W**

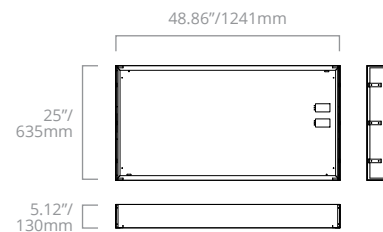

**VOL24-SMK-W**

# PHOTOMETRICS

VOL22/PS40/840/HD (Typical performance @40W)

| ZONAL LUMEN SUMMARY |         |          |
|---------------------|---------|----------|
| Zone                | Lumens  | %Fixture |
| 0-30                | 1278.43 | 25.6%    |
| 0-40                | 2090.09 | 41.8%    |
| 0-60                | 3739.43 | 74.8%    |
| 0-80                | 4835.5  | 96.7%    |
| 0-90                | 4986.19 | 99.7%    |
| 60-80               | 1096.08 | 21.9%    |
| 70-80               | 441.86  | 8.8%     |
| 80-90               | 150.69  | 3.0%     |
| 0-180               | 5002.21 | 100%     |

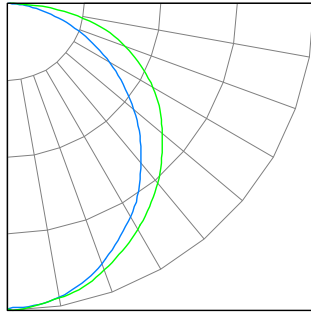

VOL24/PS50/840/HD (Typical performance @50W)

| ZONAL LUMEN SUMMARY |         |          |
|---------------------|---------|----------|
| Zone                | Lumens  | %Fixture |
| 0-30                | 1342.03 | 25.1%    |
| 0-40                | 2200.93 | 41.1%    |
| 0-60                | 3963.00 | 74.1%    |
| 0-80                | 5161.42 | 96.5%    |
| 0-90                | 5332.91 | 99.7%    |
| 60-80               | 1198.42 | 22.4%    |
| 70-80               | 487.49  | 9.1%     |
| 80-90               | 171.49  | 3.2%     |
| 0-180               | 5349.24 | 100%     |

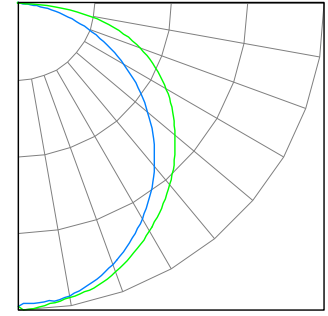

VOL22/PS40/FCCT/HD (Typical performance @40W)

| ZONAL LUMEN SUMMARY |         |          |
|---------------------|---------|----------|
| Zone                | Lumens  | %Fixture |
| 0-30                | 1364.48 | 25.6%    |
| 0-40                | 2231.37 | 41.9%    |
| 0-60                | 3994.32 | 75.0%    |
| 0-80                | 5160.86 | 96.9%    |
| 0-90                | 5310.28 | 99.7%    |
| 60-80               | 1166.54 | 21.9%    |
| 70-80               | 467.36  | 8.8%     |
| 80-90               | 149.42  | 2.8%     |
| 0-180               | 5324.78 | 100%     |

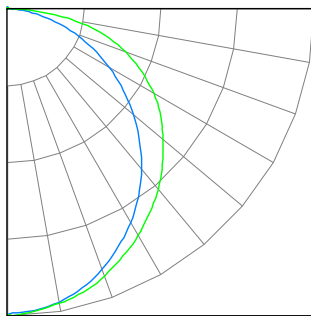

VOL24/PS50/FCCT/HD (Typical performance @50W)

| ZONAL LUMEN SUMMARY |         |          |
|---------------------|---------|----------|
| Zone                | Lumens  | %Fixture |
| 0-30                | 1374.86 | 25.1%    |
| 0-40                | 2255.59 | 41.2%    |
| 0-60                | 4064.23 | 74.2%    |
| 0-80                | 5292.26 | 96.6%    |
| 0-90                | 5462.18 | 99.7%    |
| 60-80               | 1228.03 | 22.4%    |
| 70-80               | 497.99  | 9.1%     |
| 80-90               | 169.92  | 3.1%     |
| 0-180               | 5477.54 | 100%     |

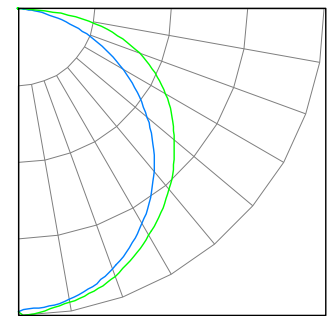

■ Vertical plane through horizontal angles 0°-180° ■ Vertical plane through horizontal angles 90°-270°

## SCALING FACTORS

| FIXTURE | WATTS             | CCT   |       |       |      |
|---------|-------------------|-------|-------|-------|------|
|         |                   | 3500K | 4000K | 5000K |      |
| VOL22   | PowerSet          | 40    | 1.00  | 1.00  | 1.02 |
|         |                   | 32    | 0.84  | 0.84  | 0.86 |
|         |                   | 26    | 0.71  | 0.71  | 0.72 |
|         | PowerSet FieldCCT | 40    | 0.94  | 1.00  | 0.96 |
|         |                   | 32    | 0.77  | 0.82  | 0.79 |
|         |                   | 26    | 0.65  | 0.69  | 0.66 |
| VOL24   | PowerSet          | 50    | 0.98  | 1.00  | 1.01 |
|         |                   | 40    | 0.79  | 0.81  | 0.82 |
|         |                   | 32    | 0.66  | 0.67  | 0.68 |
|         | PowerSet FieldCCT | 50    | 0.94  | 1.00  | 0.96 |
|         |                   | 40    | 0.74  | 0.79  | 0.76 |
|         |                   | 32    | 0.62  | 0.66  | 0.63 |